

MUNDUS

ASSEMBLY INSTRUCTIONS

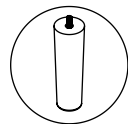

- 
A)x4
- 
B)x8
- 
C)x4
- 
D)x4
- 
E)x4
- 
F)x1

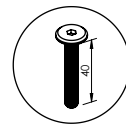
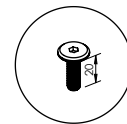
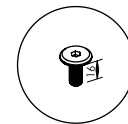
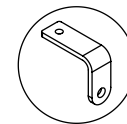
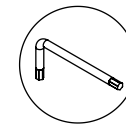
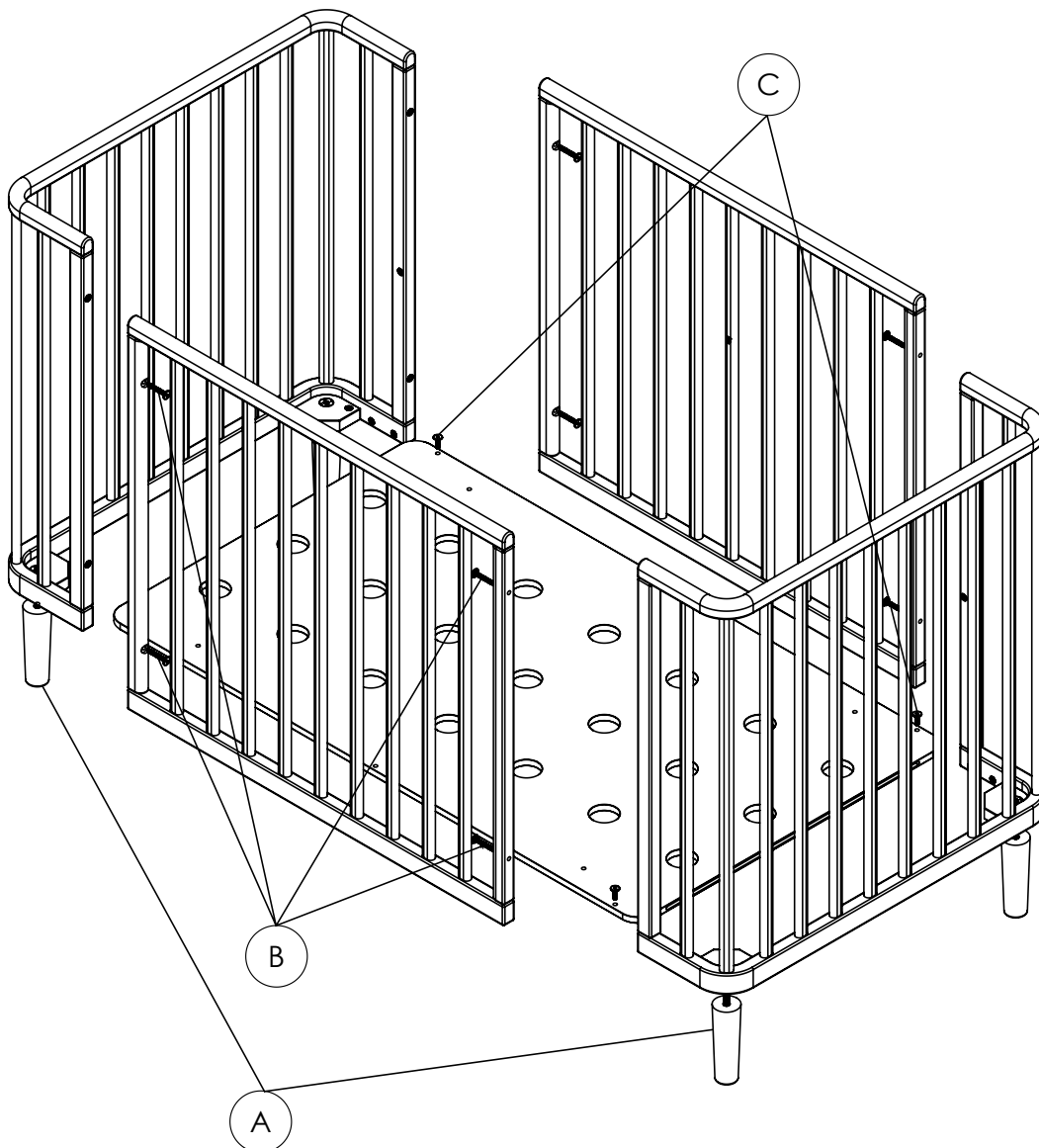

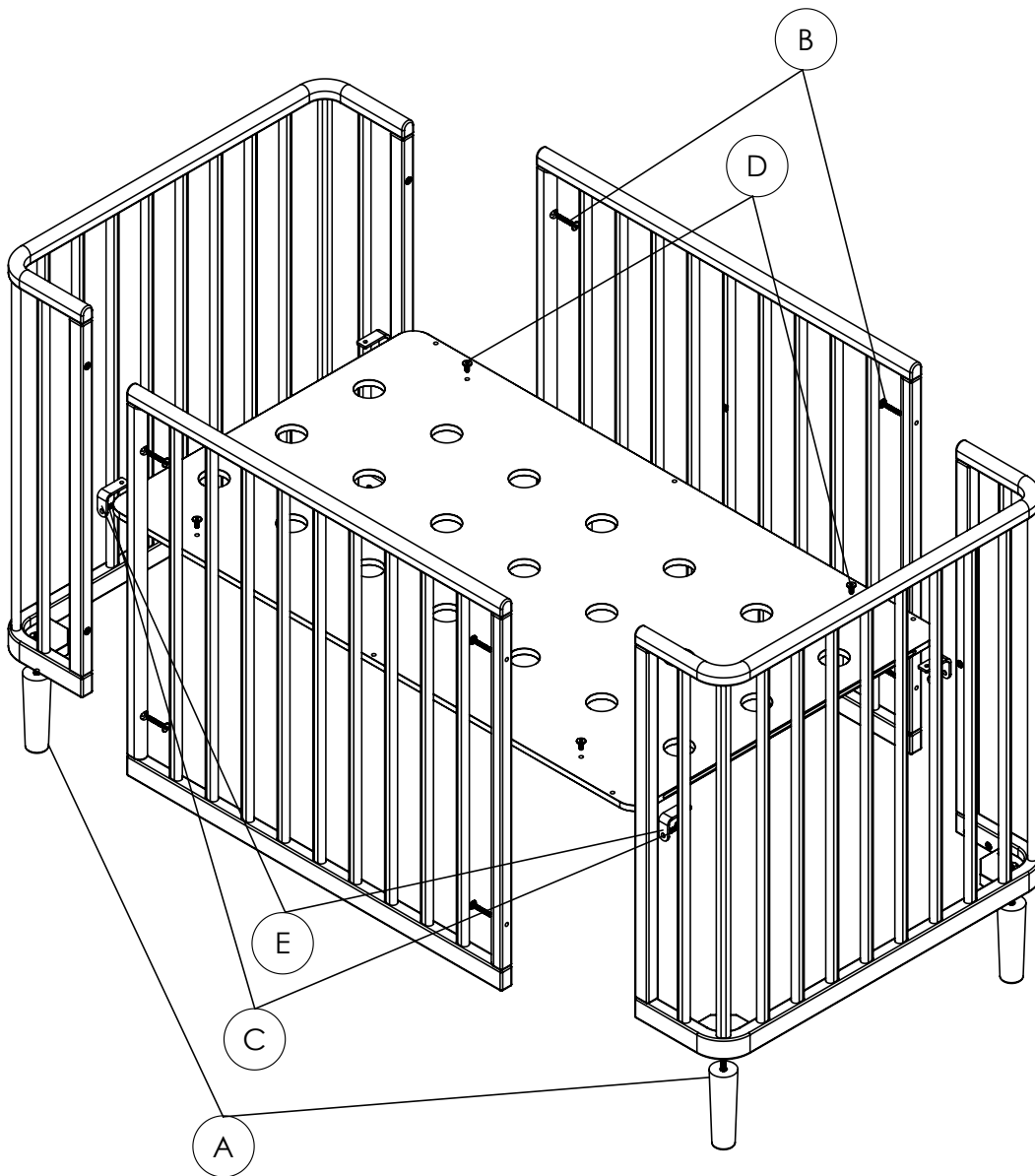
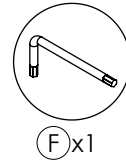
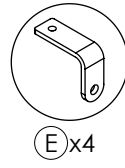
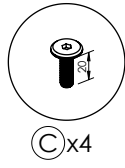
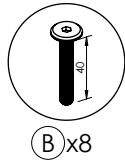
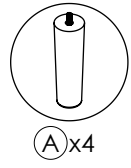

The extension kit does not come with Mundus but can be purchased separately on Better Night's webshop.

